

OEM Series: Cable-Extension Position Transducer

Incremental Encoder Output
Ranges: 0-1000 to 0-1250 mm
Compact Size • OEM Applications

A125

Specification Summary:

GENERAL

Full Stroke Ranges..... 0-1000 & 0-1250 mm
 Spool Circumference..... 125 mm
 Output Signal..... incremental (quadrature) encoder
 Accuracy..... +0.04% of F.S.
 Repeatability..... +0.02% of F.S.
 Resolution..... 0.8 to 20 pulses per mm*
 Measuring Cable..... 0.034-in dia. nylon-coated stainless steel
 Optional Measuring Cable..... 0.040-in. dia. thermoplastic
 Sensor..... incremental optical encoder
 Frame Material..... zinc-plated steel
 Weight, max..... 1 lb.

ELECTRICAL

Encoder Output Driver Options..... TTL-CMOS, open collector and line-driver
 Output Channels..... A, B and index (with and without compliments)*
 Input Voltage..... 4.5 to 26.4 VDC*
 Current Consumption..... 80 mA max.*
 Sink Current..... 20 mA max.*

ENVIRONMENTAL

Operating Temperature..... -10°C to +70°C
 Storage Temperature..... -30°C to +80°C
 Humidity..... RH 85%, no condensation
 Vibration..... 10 ~ 55 Hz / 1.5 mm 2 hr.
 Shock..... 30 G 11ms (X,Y, Z each 3 times)

**specifications may vary with configuration, please consult factory*



The A125 Cable-Extension Transducer is an optical encoder-based compact, flexible and highly accurate position feedback transducer.

The standard A125 can be simply modified to meet specific OEM requirements. Just about any encoder type can be used for your specific requirement. Designs are available for new applications or as drop-in replacements of current assemblies. You can specify custom mounting, custom electrical connections and even customer-specified life testing. Quantities are available as small as 100 units.

Outline Drawing

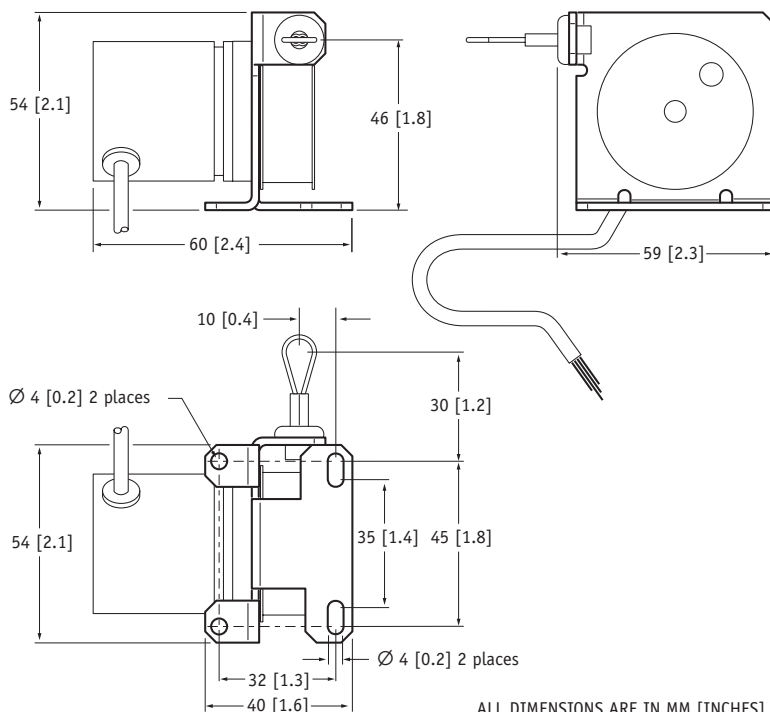

ALL DIMENSIONS ARE IN MM [INCHES]

Output Signal

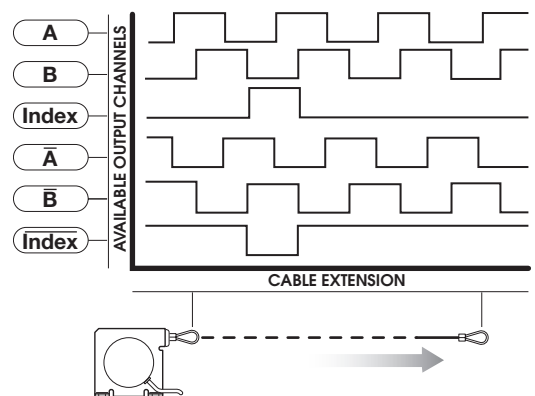

Celeco Transducer Products, Inc.
 20630 Plummer Street • Chatsworth, CA 91311
 tel: 800.423.5483 • +1.818.701.2750 • fax: +1.818.701.2799

celesco
 celesco.com • info@celesco.com

Order Form • Application Worksheet

Application *please provide a brief description of application. include exact stroke range, velocity of stroke and estimated number of cycles per year.*

Full Stroke Range *select available range or specify complete requirements*

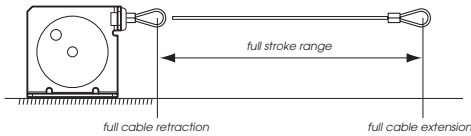

- 1000 mm
- 1250 mm
- other:

Measuring Cable



- 0.034" dia. nylon-coated stainless steel
- 0.040" dia. thermoplastic

Measuring Cable Exit

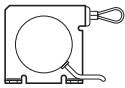

front

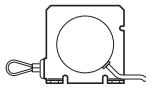

rear

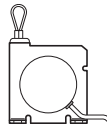

up

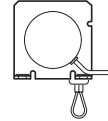

down

Encoder

TTL - CMOS compatible

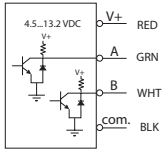

line driver

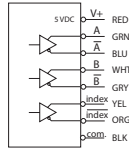

open collector

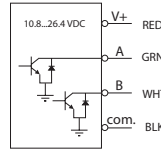

Resolution

- 0.8 pulses per mm
- 8 pulses per mm
- 16 pulses per mm
- 20 pulses per mm

Enclosure *select no cover or specify custom enclosure requirements*

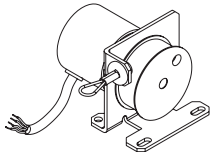

no cover

custom enclosure:

Electrical Connection

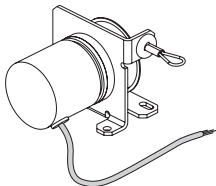

without connector

with connector

cable length:

connector

manufacturer:

manufacturer's part no.:

version: 1.0 last updated: April 14, 2005